

ON HYPERBOLIC POLYHEDRA ARISING AS CONVEX CORES OF QUASI-FUCHSIAN PUNCTURED TORUS GROUPS

A.D. MEDNYKH, J.R. PARKER, AND A.YU. VESNIN

Dedicated to Francisco Javier González Acuña on the occasion of his 60th birthday

ABSTRACT. We consider two families of hyperbolic polyhedra. With one set of face pairings, these polyhedra give the convex core of certain quasi-Fuchsian punctured torus groups. With additional face pairings, they are related to hyperbolic cone manifolds with singularities over certain links. For both families we derive formulae relating the dihedral angles, side lengths and the volume of the polyhedron.

1. INTRODUCTION

A *Kleinian* group G is a discrete subgroup of $\mathrm{PSL}(2, \mathbb{C})$, the isometry group of hyperbolic space \mathbb{H}^3 . Such a group also acts by conformal automorphisms on the Riemann sphere $\widehat{\mathbb{C}} = \partial\mathbb{H}^3$. The action on $\widehat{\mathbb{C}}$ decomposes into the *regular set* $\Omega(G)$ on which the action is properly discontinuous, and the *limit set* $\Lambda(G)$ on which the action is minimal, that is every orbit is dense. The limit set $\Lambda(G)$ is the set of accumulation points of the fixed points of G . A Kleinian group G is *Fuchsian* if $\Lambda(G)$ is a round circle.

Let S be an oriented surface of negative Euler characteristic, homeomorphic to a closed surface with at most a finite number of punctures. A finitely generated Kleinian group G is *quasi-Fuchsian* if \mathbb{H}^3/G is homeomorphic to the product of such a surface with the open interval $(0, 1)$, and if $\Omega(G)$ has exactly two simply connected G -invariant components Ω^+ and Ω^- . Equivalently, $G = \pi_1(S)$ and $\Lambda(G)$ is topological

1991 *Mathematics Subject Classification.* 30F40, 51M10, 57M50.

Key words and phrases. Hyperbolic polyhedron, quasi-Fuchsian group, hyperbolic cone-manifold, bending, convex core.

This research was partially carried out during a visit of the first author to Durham. This visit was supported by a grant from the London Mathematical Society. The third author was partially supported by the Russian Foundation for Basic Research (grant number 02-01-01118).

circle. In this situation, the quotients Ω^+/G and Ω^-/G are Riemann surfaces, both homeomorphic to S .

Let $M = \mathbb{H}^3/G$ be the 3-manifold uniformized by the Kleinian group G . The *convex core* \mathcal{C}/G of M is the smallest closed convex set containing all closed geodesics of M . This means that \mathcal{C} can be defined in the universal cover \mathbb{H}^3 as the hyperbolic *convex hull* of the limit set $\Lambda(G)$, also called the *Nielsen region* of G . If G is quasi-Fuchsian, then $\partial\mathcal{C}$ has exactly two components $\partial\mathcal{C}^+$ and $\partial\mathcal{C}^-$ which “face” the components Ω^+ and Ω^- of Ω . The quotients $\partial\mathcal{C}^+/G$ and $\partial\mathcal{C}^-/G$ are homeomorphic to Ω^+/G and Ω^-/G , respectively, and, hence, to S . In the case where G is Fuchsian, \mathcal{C} is contained in a single flat plane.

The convex hull boundary $\partial\mathcal{C}$ is made up of convex pieces of flat hyperbolic planes which meet along a disjoint set of complete geodesics called *pleating* or *bending lines* (see [2] and [3] for more discussions).

It is well known that a Kleinian group is geometrically finite if and only if its convex core has finite volume. Moreover, it is also well known that finitely generated quasi-Fuchsian groups are geometrically finite.

In the present paper we are interested in the case where S is homeomorphic to a punctured torus. So, $G = \langle X, Y \mid [X, Y] \text{ is parabolic} \rangle$, where X and Y are isometries of \mathbb{H}^3 . We will be interested in cases where certain elements of $\langle X, Y \rangle$ are purely hyperbolic. An isometry X of \mathbb{H}^3 is called purely hyperbolic if its associated matrix \mathbf{X} in $\mathrm{SL}(2, \mathbb{C})$ has trace $\mathrm{tr}(\mathbf{X})$ that is real and either greater than 2 or less than -2 . Geometrically such an isometry is a hyperbolic translation along a geodesic with no twisting.

We find hyperbolic polyhedra which are fundamental domains for the convex cores of certain quasi-Fuchsian punctured torus groups. In particular, we consider the two cases of punctured torus groups $\langle X, Y \rangle$ for which:

- (i) the isometries X and Y are purely hyperbolic;
- (ii) the isometries XY and XY^{-1} are purely hyperbolic.

These quasi-Fuchsian punctured torus groups are such that the pleating locus on each component of the convex hull boundary is a simple closed geodesic and either these geodesics are a pair of neighbours or else they are next-but-one neighbours. For each of these two types of group we find a polyhedron and face pairings so that identifying the faces of the polyhedron gives the convex core of the quasi-Fuchsian manifold (see Sections 2.1 and 3.1). These polyhedra will have all their dihedral angles equal to $\pi/2$ except for the dihedral angles along the pleating curves. We demonstrate two approaches to find relations between the lengths of these curves and the dihedral angles. In Sections 2.2 and

3.2 we use the bending formulae due to Parker and Series [12]. In Sections 2.3 and 3.3 we derive these and other formulae (which will be necessary to obtain expressions for volumes) from the Gram matrix of the polyhedra. We then go to use Schläfli's formula (see [1, 9, 14]) to obtain volumes of these polyhedra in Sections 2.4 and 3.4. In particular, we give expressions for volumes in terms of the Lobachevsky function $\Lambda(x)$, which is traditionally used to express volumes of hyperbolic 3-polyhedra and 3-manifolds. In Sections 2.5 and 3.5 we discuss links and cone-manifolds naturally associated with our polyhedra. For the first case the singular set of the cone manifold is the Borromean rings, a well known three component link, and for the second case it is a six-component link.

2. THE CASE WHERE X AND Y ARE PURELY HYPERBOLIC

2.1. Constructing the polyhedron. Let matrices $\mathbf{X}, \mathbf{Y} \in \mathrm{SL}(2, \mathbb{C})$, $\mathrm{tr}[\mathbf{X}, \mathbf{Y}] = -2$, represent isometries X and Y of \mathbb{H}^3 which generate a punctured torus group. For the rest of this section we suppose that $\mathrm{tr}(\mathbf{X})$ and $\mathrm{tr}(\mathbf{Y})$ are both real and greater than 2. (We remark that one may choose the signs of the traces of \mathbf{X} and \mathbf{Y} when lifting from $\mathrm{PSL}(2, \mathbb{C})$ to $\mathrm{SL}(2, \mathbb{C})$.) We define the multiplier of a matrix \mathbf{M} , $\lambda(\mathbf{M})$ by $\mathrm{tr}(\mathbf{M}) = 2 \cosh \lambda(\mathbf{M})$ (see [12] for details). We denote $x = \cosh \lambda(\mathbf{X}) = \frac{1}{2} \mathrm{tr}(\mathbf{X})$ and $y = \cosh \lambda(\mathbf{Y}) = \frac{1}{2} \mathrm{tr}(\mathbf{Y})$. Thus, x and y are real greater than 1 in our case. In Theorem 6.3 of [12] it is shown that either $\langle X, Y \rangle$ is Fuchsian or else the axes of X and Y are the pleating loci of the convex hull boundary of $\langle X, Y \rangle$. Specifically this theorem states that

Proposition 2.1 ([12] Theorem 6.3). *Suppose that $\langle X, Y \rangle$ is a punctured torus group with $x = \cosh \lambda(\mathbf{X}) > 1$ and $y = \cosh \lambda(\mathbf{Y}) > 1$.*

- (i) *If $x^2 + y^2 \leq x^2 y^2$ then $\langle X, Y \rangle$ is Fuchsian.*
- (ii) *If $x^2 + y^2 > x^2 y^2$ then $\langle X, Y \rangle$ is quasi-Fuchsian and the axes of X and Y are the pleating loci.*

From now on we suppose that $x^2 + y^2 > x^2 y^2$, that is the non-Fuchsian case.

We want to construct a fundamental polyhedron for the convex hull of the limit set (Nielsen region) of $\langle X, Y \rangle$. This will be $\mathcal{P} = \mathcal{P}(\alpha, \beta)$. Since \mathbf{X} , $\mathbf{Y}\mathbf{X}^{-1}\mathbf{Y}^{-1}$ and their product $\mathbf{Y}\mathbf{X}^{-1}\mathbf{Y}^{-1}\mathbf{X}$ all have real trace, the corresponding isometries X and $YX^{-1}Y^{-1}$ generate a Fuchsian group. Similarly, since \mathbf{Y} , $\mathbf{X}^{-1}\mathbf{Y}^{-1}\mathbf{X}$ and their product $\mathbf{Y}\mathbf{X}^{-1}\mathbf{Y}^{-1}\mathbf{X}$ all have real trace, the corresponding isometries Y and $X^{-1}Y^{-1}X$ also generate a Fuchsian group.

- Let Π_+ denote the plane preserved by the group $\langle X, YX^{-1}Y^{-1} \rangle$;
- Let Π_- denote the plane preserved by the group $\langle Y, X^{-1}Y^{-1}X \rangle$.

It will follow from our construction that Π_+ and Π_- are support planes for the convex hull boundary of $\langle X, Y \rangle$. In [12] this was shown using a different method.

We define geodesics γ_X , γ_Y and γ_0 by:

- γ_X is the axis of X and γ_Y is the axis of Y ;
- γ_0 is the common perpendicular of γ_X and γ_Y .

A halfturn is an elliptic isometry of order 2 fixing a geodesic pointwise. We define halfturns I_0 , I_1 and I_2 as follows.

- Let I_0 to be the halfturn fixing γ_0 .
- Define I_1 by $I_1 = I_0X$. Then I_1 is a halfturn fixing a geodesic γ_1 .
- Define I_2 by $I_2 = YI_0$. Then I_2 is a halfturn fixing a geodesic γ_2 .

Then we have

$$\begin{aligned} I_0XI_0 &= X^{-1}, & I_1XI_1 &= X^{-1}, & I_2XI_2 &= YX^{-1}Y^{-1}, \\ I_0YI_0 &= Y^{-1}, & I_1YI_1 &= X^{-1}Y^{-1}X, & I_2YI_2 &= Y^{-1}. \end{aligned}$$

Lemma 2.2. *The halfturn I_2 preserves the plane Π_+ and the halfturn I_1 preserves the plane Π_- .*

Proof. Since $I_2XI_2 = YX^{-1}Y^{-1}$ it is clear that I_2 swaps the axes of X and YXY^{-1} . These geodesics span the plane Π_+ and so I_2 preserves this plane. Similarly, since I_1 swaps the axes of Y and $X^{-1}YX$, it preserves Π_- . \square

We now define reflections R_0 and R'_0 in planes Π_0 and Π'_0 as follows:

- Let R_0 be reflection in the plane Π_0 containing γ_0 and γ_X .
- Let R'_0 be reflection in the plane Π'_0 containing γ_0 and γ_Y .

Then we have

$$R_0XR_0 = X, \quad R'_0YR'_0 = Y.$$

Lemma 2.3. *The plane Π_0 is orthogonal to γ_Y and the plane Π'_0 is orthogonal to γ_X .*

Proof. In order to show this, we calculate the complex distance $\delta(X, Y)$ between γ_X and γ_Y and show that $\cosh \delta(X, Y)$ is purely imaginary.

We find $\cosh \delta(X, Y)$ by constructing a right angled hexagon and using Fenchel's generalised cosine rule (see [4]). Doing this we obtain the following formula (which is (1.3) of [12]).

$$(1) \quad \cosh \delta(X, Y) = \frac{\cosh \lambda(\mathbf{XY}) - \cosh \lambda(\mathbf{X}) \cosh \lambda(\mathbf{Y})}{\sinh \lambda(\mathbf{X}) \sinh \lambda(\mathbf{Y})}$$

From the well known expression for the trace of the commutator

$$(2) \quad \text{tr}[\mathbf{X}, \mathbf{Y}] = \text{tr}^2(\mathbf{X}) + \text{tr}^2(\mathbf{Y}) + \text{tr}^2(\mathbf{XY}) - \text{tr}(\mathbf{X}) \text{tr}(\mathbf{Y}) \text{tr}(\mathbf{XY}) - 2,$$

we see that the traces of \mathbf{X} , \mathbf{Y} , \mathbf{XY} satisfy the Markov equation [12]:

$$(3) \quad \text{tr}^2(\mathbf{X}) + \text{tr}^2(\mathbf{Y}) + \text{tr}^2(\mathbf{XY}) = \text{tr}(\mathbf{X}) \text{tr}(\mathbf{Y}) \text{tr}(\mathbf{XY}).$$

Therefore

$$(4) \quad x^2 + y^2 + \cosh^2 \lambda(\mathbf{XY}) = 2xy \cosh \lambda(\mathbf{XY}).$$

Hence

$$\cosh^2 \delta(X, Y) = \frac{(\cosh \lambda(\mathbf{XY}) - xy)^2}{(x^2 - 1)(y^2 - 1)} = \frac{x^2 y^2 - x^2 - y^2}{(x^2 - 1)(y^2 - 1)} < 0,$$

where we have used $x > 1$, $y > 1$ and $x^2 + y^2 > x^2 y^2$. Thus the imaginary part of the complex distance between the axes of X and Y is $\pi/2$ (it also can be seen by the arguments of [7]). \square

A consequence of this lemma is

$$R_0 R'_0 = I_0, \quad R_0 Y R_0 = Y^{-1}, \quad R'_0 X R'_0 = X^{-1}.$$

Moreover, define

- $R_1 = R'_0 X$, a reflection fixing a plane Π_1 and
- $R_2 = Y R_0$, a reflection fixing a plane Π_2 .

Then γ_X is the common orthogonal of Π_1 and Π'_0 . The distance between these planes is $\lambda(\mathbf{X})$, the multiplier of \mathbf{X} . Also Π_1 contains γ_0 and γ_1 . Similarly, γ_Y is the common orthogonal of Π_2 and Π_0 ; the distance between them is $\lambda(\mathbf{Y})$; and Π_2 contains γ_0 and γ_2 .

Lemma 2.4. *The planes Π_1 and Π_2 are each orthogonal to both of the planes Π_+ and Π_- .*

Proof. We have

$$R_1(X)R_1 = (R'_0 X)X(X^{-1}R'_0) = R'_0 X R'_0 = X^{-1}.$$

Also

$$\begin{aligned} R_1(YX^{-1}Y^{-1}X)R_1 &= (R'_0 X)YX^{-1}Y^{-1}X(X^{-1}R'_0) \\ &= (R'_0 X R'_0)(R'_0 Y R'_0)(R'_0 X^{-1}R'_0)(R'_0 Y^{-1}R'_0) \\ &= XY^{-1}X^{-1}Y \\ &= (YX^{-1}Y^{-1}X)^{-1}. \end{aligned}$$

Therefore R_1 preserves the plane Π_+ preserved by X and $YX^{-1}Y^{-1}$.

Moreover

$$R_1(Y)R_1 = (R'_0 X)Y(X^{-1}R'_0) = X^{-1}YX = (X^{-1}Y^{-1}X)^{-1}.$$

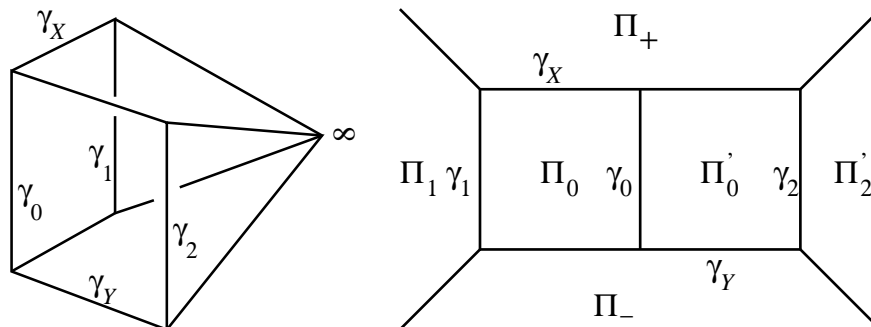
FIGURE 1. The polyhedron $\mathcal{P}'(\alpha, \beta)$.

Therefore R_1 swaps the axes of Y and $X^{-1}YX$, which both lie in Π_- . Therefore R_1 also preserves the plane Π_- preserved by Y and $X^{-1}Y^{-1}X$. Since Π_1 is distinct from Π_+ and Π_- we see that it must be orthogonal to them both.

A similar argument shows Π_2 is orthogonal to both Π_+ and Π_- . \square

Summarising we have:

- The planes Π_0 and Π'_0 meet at right angles along γ_0 ;
- the planes Π_0 and Π_1 meet at right angles along γ_1 ;
- the planes Π'_0 and Π_2 meet at right angles along γ_2 ;
- the planes Π_+ and Π_0 meet along γ_X at dihedral angle say $\alpha/2$;
- the planes Π_- and Π'_0 meet along γ_Y at dihedral angle say $\beta/2$;
- the planes Π_+ and Π'_0 meet at right angles;
- the planes Π_- and Π_0 meet at right angles;
- the planes Π_+ and Π_1 meet at right angles;
- the planes Π_- and Π_1 meet at right angles;
- the planes Π_+ and Π_2 meet at right angles;
- the planes Π_- and Π_2 meet at right angles.

Therefore, the intersection of halfspaces bounded by Π_+ , Π_- , Π_0 , Π'_0 , Π_1 and Π_2 is a polyhedron, which we denote by $\mathcal{P}' = \mathcal{P}'(\alpha, \beta)$, with six faces and eleven edges, having one vertex at infinity (ideal vertex) (see Figure 1). We remark that the polyhedron $\mathcal{P}'(\alpha, \beta)$ presented in Figure 1 can be regarded as a degenerated Lambert cube $\mathcal{L}(\alpha/2, \beta/2, 0)$.

In this polyhedron, and all subsequent polyhedra we shall consider, the 3-valent vertices are interior points of \mathbb{H}^3 and the 4-valent vertices are ideal vertices on $\partial\mathbb{H}^3$. We denote these vertices by the symbol ∞ in the figures.

We are now in a position to construct the polyhedron $\mathcal{P} = \mathcal{P}(\alpha, \beta)$. The polyhedron \mathcal{P} will be the common intersection of halfspaces bounded by Π_+ , Π_- , Π_1 , Π_2 and their images under I_0 . This consists of four

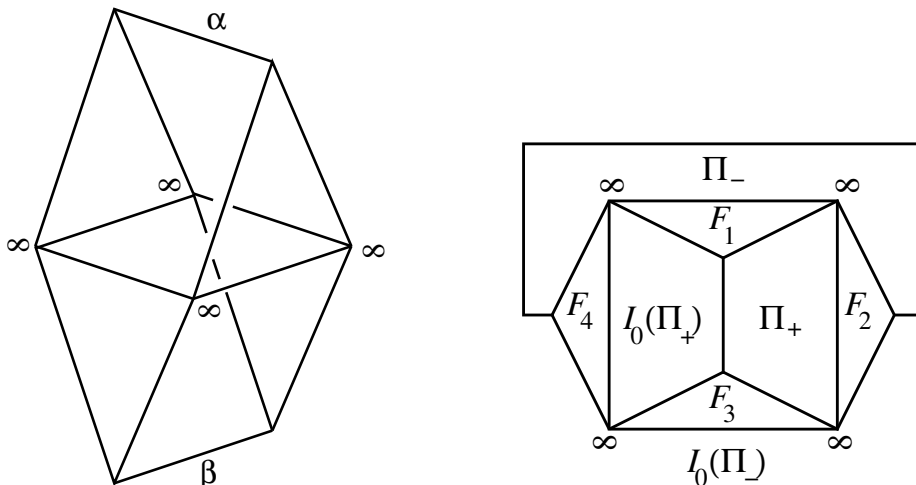
FIGURE 2. The polyhedron $\mathcal{P}(\alpha, \beta)$.

copies of $\mathcal{P}'(\alpha, \beta)$ glued together along the planes Π_0 and Π'_0 . For $i = 1, 2$ let F_i, F_{i+2} be the faces of \mathcal{P} contained in $\Pi_i, I_0(\Pi_i)$ respectively. We claim that \mathcal{P} has the combinatorial structure shown in Figure 2. In particular:

Proposition 2.5. *The polyhedron \mathcal{P} has eight vertices. Four of these vertices are the fixed points of the parabolic maps $YX^{-1}Y^{-1}X, X^{-1}Y^{-1}XY, Y^{-1}XYX^{-1}$ and $XYX^{-1}Y^{-1}$. The other four are the intersection of the axes of the following pairs of transformations $X, I_1; X, I_0I_1I_0; Y, I_2; Y, I_0I_2I_0$. Every edge with (at least) one ideal endpoint has dihedral angle $\pi/2$.*

Proof. We will sketch the reason for this to be true. For example, Π_1 intersects Π_+ along the geodesic with one endpoint the fixed point of $YX^{-1}Y^{-1}X$ and passing through the intersection of the axes of X and I_2 . We have already seen these two planes intersect orthogonally. Likewise, Π_1 intersects Π_- along the geodesic with endpoints the fixed points of $YX^{-1}Y^{-1}X$ and $X^{-1}Y^{-1}XY$. Again, we have seen that these planes intersect orthogonally. The other edges and vertices may be found similarly. \square

Proposition 2.6. *The polyhedron \mathcal{P} with the side pairings $X : F_1 \longrightarrow F_3$ and $Y : F_4 \longrightarrow F_2$ is a fundamental polyhedron for the convex core of the group $\langle X, Y \rangle$.*

Proof. Define

$$\mathcal{N} = \bigcup_{T \in \langle X, Y \rangle} T(\mathcal{P}).$$

We show that \mathcal{N} is the smallest group invariant convex subset of \mathbb{H}^3 and so is the Nielsen region (convex hull of the limit set) of $\langle X, Y \rangle$. This means that $\mathcal{N}/\langle X, Y \rangle$ is the convex core.

It is clear that \mathcal{P} is convex. Now consider \mathcal{P} and $X(\mathcal{P})$. These two polyhedra share a face $F_3 = I_0(F_1) = X(F_1)$ (since F_1 is sent to itself by I_1 and $X = I_0I_1$). The dihedral angles along the three edges of \mathcal{P} bounding F_3 are all $\pi/2$. Similarly, the dihedral angles along the three edges of $X(\mathcal{P})$ bounding $X(F_1)$ are all $\pi/2$. Thus gluing these two polyhedra along their common face gives another convex polyhedron. Proceeding by induction, we see that \mathcal{N} itself is convex. Thus \mathcal{N} contains the smallest $\langle X, Y \rangle$ invariant convex set, the Nielsen region.

The intersection of Π_+ with $\partial\mathcal{N}$ is formed by removing from Π_+ infinitely many hyperbolic halfspaces bounded by the axes of X, YXY^{-1} and all their images under $\langle X, YXY^{-1} \rangle$. This is the Nielsen region of this subgroup and so is contained in the Nielsen region of $\langle X, Y \rangle$. Similarly, every other face of \mathcal{P} is contained in the Nielsen region of $\langle X, Y \rangle$. If the boundary of \mathcal{N} is contained in the Nielsen region then, by convexity, the whole of \mathcal{N} must be as well. Thus \mathcal{N} both contains and is contained in the Nielsen region. This proves the result. \square

2.2. The trigonometry from bending formulae. In this section we use the bending formulae of [12] to show that the polyhedron \mathcal{P} only depends on the dihedral angles across γ_X and γ_Y .

The only free parameters of \mathcal{P} are the lengths and dihedral angles in the sides of \mathcal{P} contained in the axes of X and Y . According to the above notation, α is the dihedral angle between Π_+ and $I_0(\Pi_+)$ along the axis of X and we define ℓ_α to be length of the corresponding side of \mathcal{P} . (We choose the convention that α is the interior angle of \mathcal{P} and remark that this is the opposite convention to that used in [12].) Similarly, as above, β is the dihedral angle between Π_- and $I_0(\Pi_-)$ along the axis of Y and we define ℓ_β to be length of the corresponding side of \mathcal{P} .

In [12] formulae were developed that relate the lengths and complex shear along the pleating locus of convex hull boundaries. As indicated above, the bending angles of [12] are related to our angles by $\theta = \pi - \alpha$, $\phi = \pi - \beta$. Similarly, the length ℓ_α is the length of the geodesic represented by X and so is twice $\lambda(\mathbf{X})$. Similarly for ℓ_β . That is $\lambda(\mathbf{X}) = \ell_\alpha/2$ and $\lambda(\mathbf{Y}) = \ell_\beta/2$. In the proof of Theorem 6.1 of [12], it was shown that

$$\sinh \lambda(\mathbf{X}) = \sin(\phi/2) \cot(\theta/2), \quad \sinh \lambda(\mathbf{Y}) = \sin(\theta/2) \cot(\phi/2).$$

In our notation, these formulae give us

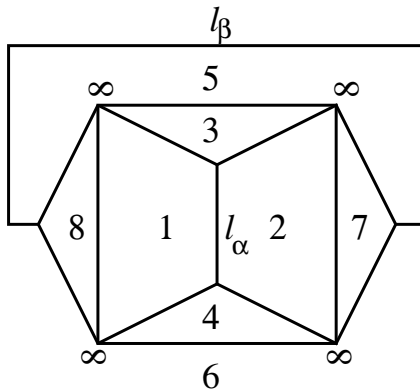
FIGURE 3. The projection of $\mathcal{P}(\alpha, \beta)$.

Proposition 2.7. *The (essential) angles α , β and edge lengths ℓ_α , ℓ_β of $\mathcal{P}(\alpha, \beta)$ are related by*

$$(5) \quad \sinh(\ell_\alpha/2) = \cos(\beta/2) \tan(\alpha/2), \quad \sinh(\ell_\beta/2) = \cos(\alpha/2) \tan(\beta/2).$$

These formulae indicate that the polyhedron \mathcal{P} only depends on the angles α and β , where $\alpha, \beta \in (0, \pi)$. This justifies our notation $\mathcal{P} = \mathcal{P}(\alpha, \beta)$.

It is easy to see that formulae (5) imply the following:

Proposition 2.8 (Tangent Rule). *The (essential) angles α , β and the edge lengths ℓ_α , ℓ_β of the polyhedron $\mathcal{P}(\alpha, \beta)$ are related by*

$$(6) \quad \frac{\tan(\alpha/2)}{\tanh(\ell_\alpha/2)} = \frac{\tan(\beta/2)}{\tanh(\ell_\beta/2)} = T,$$

where T is a positive number given by

$$(7) \quad T^2 = \tan^2(\alpha/2) + \tan^2(\beta/2) + 1.$$

2.3. The trigonometry from the Gram matrix. In this section we use the Gram matrix of the polyhedron to re-derive the formulae of the previous section.

Consider the numbering of faces of $\mathcal{P}(\alpha, \beta)$ as shown in its projection in Figure 3. Let $\rho(j, k)$ be the hyperbolic distance between the faces j and k . Then we write $A = \cosh \ell_\alpha = \cosh \rho(3, 4)$, $B = \cosh \ell_\beta = \cosh \rho(7, 8)$, $u = \cosh \rho(1, 7) = \cosh \rho(2, 8)$, $v = \cosh \rho(3, 6) = \cosh \rho(4, 5)$.

Denote by $G_{\alpha,\beta}$ the Gram matrix of the polyhedron $\mathcal{P}(\alpha,\beta)$:

$$G_{\alpha,\beta} = \begin{pmatrix} 1 & -\cos \alpha & 0 & 0 & -1 & -1 & -u & 0 \\ -\cos \alpha & 1 & 0 & 0 & -1 & -1 & 0 & -u \\ 0 & 0 & 1 & A & 0 & -v & -1 & -1 \\ 0 & 0 & -A & 1 & -v & 0 & -1 & -1 \\ -1 & -1 & 0 & -v & 1 & -\cos \beta & 0 & 0 \\ -1 & -1 & -v & 0 & -\cos \beta & 1 & 0 & 0 \\ -u & 0 & -1 & -1 & 0 & 0 & 1 & -B \\ 0 & -u & -1 & -1 & 0 & 0 & -B & 1 \end{pmatrix}$$

Denote by $G(i_1, i_2, \dots, i_k)$, $k \leq 8$, the diagonal minor of $G_{\alpha,\beta}$, formed by rows and columns with numbers i_1, i_2, \dots, i_k . Since the rank of $G_{\alpha,\beta}$ is equal to 4 the determinants of each of its 5×5 -minors $\det G(i_1, i_2, i_3, i_4, i_5)$ vanishes. This gives equations relating the entries of $G_{\alpha,\beta}$. More precisely, taking $(i_1, i_2, i_3, i_4, i_5)$ to be $(1, 2, 3, 4, 5)$, $(1, 2, 3, 4, 8)$, $(2, 5, 6, 7, 8)$, $(4, 5, 6, 7, 8)$, respectively, we will get following four equations.

$$(8) \quad v^2 = (A^2 - 1) \frac{1 + \cos \alpha}{1 - \cos \alpha},$$

$$(9) \quad u^2 = (1 - \cos^2 \alpha) \frac{A + 1}{A - 1},$$

$$(10) \quad u^2 = (B^2 - 1) \frac{1 + \cos \beta}{1 - \cos \beta},$$

$$(11) \quad v^2 = (1 - \cos^2 \beta) \frac{B + 1}{B - 1}.$$

Recall that values A, B, u, v are greater than 1 in these equations. Taking $t = uv$ and calculating it in two ways using (8), (9) and using (10), (11) we obtain:

$$(12) \quad t = (1 + \cos \alpha)(A + 1) = (1 + \cos \beta)(B + 1).$$

Therefore

$$(13) \quad A = \frac{t}{1 + \cos \alpha} - 1, \quad B = \frac{t}{1 + \cos \beta} - 1.$$

It is easy to see from (8), (11) and (13) that t satisfies the equation

$$(t - 2 - 2 \cos \alpha)(t - 2 - 2 \cos \beta) = (1 - \cos^2 \alpha)(1 - \cos^2 \beta).$$

This is equivalent to:

$$(t - 2 - \cos \alpha - \cos \beta)^2 = (1 - \cos \alpha \cos \beta)^2.$$

Therefore there are two possibilities. Either

$$t - 2 - \cos \alpha - \cos \beta = -1 + \cos \alpha \cos \beta$$

or

$$t - 2 - \cos \alpha - \cos \beta = 1 - \cos \alpha \cos \beta.$$

In the first case

$$t = (1 + \cos \alpha)(1 + \cos \beta),$$

which contradicts (12) since $A > 1$ and $B > 1$. In the second case

$$t = 4 - (1 - \cos \alpha)(1 - \cos \beta).$$

Hence

$$\cosh^2(\ell_\alpha/2) = \frac{A+1}{2} = \frac{t}{2+2\cos\alpha} = \frac{1 - \sin^2(\alpha/2) \sin^2(\beta/2)}{\cos^2(\alpha/2)}$$

and

$$\cosh^2(\ell_\beta/2) = \frac{B+1}{2} = \frac{t}{2+2\cos\beta} = \frac{1 - \sin^2(\alpha/2) \sin^2(\beta/2)}{\cos^2(\beta/2)}.$$

It is easy to see that simplifying and taking square roots we will get the formulae (5) obtained earlier using the methods of [12]. Also, Proposition 2.8 follows immediately.

2.4. Volume formulae. In this section we use the Schläfli formula and the computations of the previous sections to find the volume of $\mathcal{P}(\alpha, \beta)$.

Define $V = V(\alpha, \beta) = \mathbf{Vol} \mathcal{P}(\alpha, \beta)$ to be the hyperbolic volume of $\mathcal{P}(\alpha, \beta)$. To find V we use the Schläfli formula (see [9] and [14] for details):

$$dV = -\frac{\ell_\alpha}{2}d\alpha - \frac{\ell_\beta}{2}d\beta.$$

Set $M = \tan(\alpha/2)$, $N = \tan(\beta/2)$ for $0 < \alpha, \beta < \pi$. Then $d\alpha = \frac{2dM}{1+M^2}$ and $d\beta = \frac{2dN}{1+N^2}$. Using equation (6), we obtain $\ell_\alpha = 2\operatorname{arctanh}(M/T)$ and $\ell_\beta = 2\operatorname{arctanh}(N/T)$. We have to integrate the differential form

$$\omega = -\frac{dV}{2} = \operatorname{arctanh}(M/T) \frac{dM}{1+M^2} + \operatorname{arctanh}(N/T) \frac{dN}{1+N^2},$$

where $T^2 = M^2 + N^2 + 1$. In order to do so, consider the extended differential form $\Omega = \Omega(M, N, T)$ of three independent variables M, N, T :

$$\begin{aligned} \Omega &= \operatorname{arctanh}(M/T) \frac{dM}{1+M^2} + \operatorname{arctanh}(N/T) \frac{dN}{1+N^2} \\ &\quad + \log \left[\frac{(T^2 - M^2)(T^2 - N^2)}{(1+M^2)(1+N^2)} \right] \frac{dT}{1+T^2}. \end{aligned}$$

Note that Ω satisfies the following properties:

- Ω is smooth and exact in the region

$$G = \{(M, N, T) \in \mathbb{R}^3 : M > 0, N > 0, T > 0\};$$

- $\Omega = \omega$ for all $(M, N, T) \in G$ satisfying equation $T^2 = M^2 + N^2 + 1$.

Let us consider

$$W = W(M, N) = \int_T^{+\infty} \log \left[\frac{(t^2 - M^2)(t^2 - N^2)}{(1 + M^2)(1 + N^2)} \right] \frac{dt}{1 + t^2}$$

where T is a positive root of the equation $T^2 = M^2 + N^2 + 1$. Straightforward calculations give

$$\frac{\partial W}{\partial M} = -\frac{2\operatorname{arctanh}(M/T)}{1 + T^2}, \quad \frac{\partial W}{\partial N} = -\frac{2\operatorname{arctanh}(N/T)}{1 + T^2}$$

and $W(M, N) \rightarrow 0$ as $M, N \rightarrow \infty$.

Using $M = \tan(\alpha/2)$ and $N = \tan(\beta/2)$, we see that the volume function $V = V(\alpha, \beta) = V(M, N)$ satisfies the following conditions:

$$\begin{aligned} \frac{\partial V}{\partial M} &= \frac{\partial V}{\partial \alpha} \cdot \frac{\partial \alpha}{\partial M} = -\frac{\ell_\alpha}{2} \cdot \frac{2}{1 + M^2} = -\frac{2 \operatorname{arctanh}(M/T)}{1 + M^2}, \\ \frac{\partial V}{\partial N} &= \frac{\partial V}{\partial \beta} \cdot \frac{\partial \beta}{\partial N} = -\frac{\ell_\beta}{2} \cdot \frac{2}{1 + N^2} = -\frac{2 \operatorname{arctanh}(N/T)}{1 + N^2}, \end{aligned}$$

and $V(M, N) \rightarrow 0$ as $M, N \rightarrow \infty$. The last follows from the fact that $\mathcal{P}(\alpha, \beta)$ collapses to be flat as α (or β) tends to π . Hence, we conclude that $V(M, N) = W(M, N)$ for all $M, N > 0$.

Theorem 2.9. *Let α and β be angles in the interval $(0, \pi)$. The volume of the polyhedron $\mathcal{P}(\alpha, \beta)$ is given by the formula*

$$(14) \quad \mathbf{Vol} \mathcal{P}(\alpha, \beta) = \int_T^\infty \log \left[\frac{(t^2 - M^2)(t^2 - N^2)}{(1 + M^2)(1 + N^2)} \right] \frac{dt}{1 + t^2},$$

where $M = \tan(\alpha/2)$, $N = \tan(\beta/2)$ and T is a positive root of the equation $T^2 = M^2 + N^2 + 1$.

Recall that the Lobachevsky function $\Lambda(x)$ is defined by the formula (see [9] and [14]):

$$\Lambda(x) = -\int_0^x \log |2 \sin \zeta| d\zeta.$$

To represent the volume of $\mathcal{P}(\alpha, \beta)$ in terms of the Lobachevsky function, we will use the following observation.

Lemma 2.10. *Consider*

$$\mathbf{I}(L, S) = \int_S^{+\infty} \log \left| \frac{\zeta^2 - L^2}{1 + L^2} \right| \frac{d\zeta}{1 + \zeta^2},$$

where $L = \tan \mu$, $S = \tan \sigma$, and $0 < \mu, \sigma < \pi$. Then

$$\mathbf{I}(L, S) = \Delta(\mu, \sigma) - \Delta(\pi/2, \sigma),$$

where $\Delta(\mu, \sigma) = \Lambda(\mu + \sigma) - \Lambda(\mu - \sigma)$.

Proof. Set $\zeta = \tan \tau$, $0 \leq \tau \leq \pi/2$. We have

$$\begin{aligned} \mathbf{I}(L, S) &= \int_S^{+\infty} \log \left| \frac{\zeta^2 - L^2}{1 + L^2} \right| \frac{d\zeta}{1 + \zeta^2} \\ &= \int_\sigma^{\pi/2} \log \left| \frac{\sin(\tau - \mu) \sin(\tau + \mu)}{\sin(\tau - \pi/2) \sin(\tau + \pi/2)} \right| d\tau \\ &= \int_\sigma^{\pi/2} \log |2 \sin(\tau - \mu)| d\tau + \int_\sigma^{\pi/2} \log |2 \sin(\tau + \mu)| d\tau \\ &\quad - \int_\sigma^{\pi/2} \log |2 \sin(\tau - \pi/2)| d\tau - \int_\sigma^{\pi/2} \log |2 \sin(\tau + \pi/2)| d\tau \\ &= \int_{\sigma+\mu}^{\pi/2+\mu} \log |2 \sin \eta| d\eta + \int_{\sigma-\mu}^{\pi/2-\mu} \log |2 \sin \eta| d\eta \\ &\quad - \int_{\sigma+\pi/2}^{\pi} \log |2 \sin \eta| d\eta - \int_{\sigma-\pi/2}^0 \log 2 |\sin \eta| d\eta \\ &= -\Lambda(\pi/2 + \mu) + \Lambda(\sigma + \mu) - \Lambda(\pi/2 - \mu) + \Lambda(\sigma - \mu) \\ &\quad + \Lambda(\pi) - \Lambda(\sigma + \pi/2) + \Lambda(0) - \Lambda(\sigma - \pi/2) \\ &= \Lambda(\mu + \sigma) - \Lambda(\mu - \sigma) - (\Lambda(\pi/2 + \sigma) - \Lambda(\pi/2 - \sigma)) \\ &= \Delta(\mu, \sigma) - \Delta(\pi/2, \sigma), \end{aligned}$$

where we used well-known properties of the Lobachevsky function (see [14] for details). \square

From Theorem 2.9 and Lemma 2.10 we immediately get the following expression for the volume.

Corollary 2.11. *The volume of a convex hull $\mathcal{P}(\alpha, \beta)$, where $0 < \alpha, \beta < \pi$, is given by the formula*

$$(15) \quad \mathbf{Vol} \mathcal{P}(\alpha, \beta) = \Delta(\alpha/2, \theta) + \Delta(\beta/2, \theta) - 2\Delta(\pi/2, \theta),$$

where $\Delta(\mu, \sigma) = \Lambda(\mu + \sigma) - \Lambda(\mu - \sigma)$, and θ , with $0 < \theta < \pi/2$, is the principal parameter defined by $\tan^2 \theta = \tan^2(\alpha/2) + \tan^2(\beta/2) + 1$.

As observed above, the polyhedron $\mathcal{P}(\alpha, \beta)$ is four copies of the degenerate Lambert cube $\mathcal{L}(\alpha/2, \beta/2, 0)$. Moreover, the parameter θ , $0 < \theta < \pi/2$, such that $T = \tan \theta$ for T defined by (7), is the principal parameter of the Lambert cube $\mathcal{L}(\alpha/2, \beta/2, 0)$ introduced in [6]. Thus, the expression for the volume from (15) is, naturally, four times more than the expression for the volume of the Lambert cube $\mathcal{L}(\alpha/2, \beta/2, 0)$ given by R. Kellerhals in [6].

2.5. The associated cone manifolds. It is interesting remark that volumes of convex hulls coincide or are commensurable with volumes of well-known cone-manifolds.

For the case $\beta = \alpha$ we have

Corollary 2.12. *The volume of a convex hull $\mathcal{P}(\alpha, \alpha)$, $0 < \alpha < \pi$ is given by the formula*

$$(16) \quad \mathbf{Vol} \mathcal{P}(\alpha, \alpha) = 2 \int_{\alpha}^{\pi} \operatorname{arcsinh}(\sin(\zeta/2)) d\zeta.$$

Proof. We have $\frac{d}{d\alpha}V(\alpha, \alpha) = 2\frac{\partial V}{\partial \alpha} = -\ell_{\alpha}$, $\tanh(\ell_{\alpha}/2) = \frac{M}{T}$, and $T^2 = 2 \tan^2(\alpha/2) + 1 = 2M^2 + 1$. Hence

$$\sinh^2(\ell_{\alpha}/2) = \frac{\tanh^2(\ell_{\alpha}/2)}{1 - \tanh^2(\ell_{\alpha}/2)} = \frac{M^2}{T^2 - M^2} = \frac{M^2}{M^2 + 1} = \sin^2(\alpha/2),$$

that is $\sinh(\ell_{\alpha}/2) = \sin(\alpha/2)$. Since $V(\pi, \pi) = 0$ the result follows. \square

The formula we have obtained coincides with the volume formula for the Whitehead cone-manifold $\mathcal{W}(\alpha, 0)$ whose singular set is the Whitehead link with the cone angle α on one cusp and the complete hyperbolic structure on the other (see [11]).

Denote by $\mathcal{B}(\alpha, \beta, 0)$ a Borromean cone-manifold whose singular set are Borromean rings with cone angles α and β on two components and a complete hyperbolic cusp on the third one (see Figure 4).

Recall that the fundamental set of $\mathcal{B}(\alpha, \beta, 0)$ consists of eight copies of the Lambert cube $\mathcal{L}(\alpha/2, \beta/2, 0)$ (see, for example [5]). Hence we immediately get the following

Proposition 2.13. *The volume of the convex hull $\mathcal{P}(\alpha, \alpha)$ coincides with the volume of the Whitehead link cone-manifold $\mathcal{W}(\alpha, 0)$. The volume of the convex hull $\mathcal{P}(\alpha, \beta)$ is equal to one half of the volume of the Borromean cone-manifold $\mathcal{B}(\alpha, \beta, 0)$.*

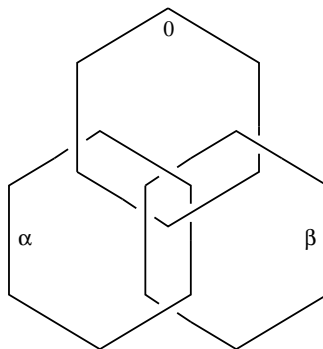
FIGURE 4. *The Borromean rings.*3. THE CASE WHERE XY AND XY^{-1} ARE PURELY HYPERBOLIC

3.1. Constructing the polyhedron. Let matrices $\mathbf{X}, \mathbf{Y} \in \mathrm{SL}(2, \mathbb{C})$ with $\mathrm{tr}[\mathbf{X}, \mathbf{Y}] = -2$ represent isometries X and Y of \mathbf{H}^3 which generate a punctured torus group. For the rest of this section we suppose that $\mathrm{tr}(\mathbf{XY})$ and $\mathrm{tr}(\mathbf{XY}^{-1})$ are both real and greater than 2. Thus both XY and XY^{-1} are purely hyperbolic. We will show that either $\langle X, Y \rangle$ is Fuchsian or else the axes of XY and XY^{-1} are the pleating loci of the convex hull boundary.

From the expression for the trace of the commutator given above (2), we see that the traces of \mathbf{X} , \mathbf{Y} , \mathbf{XY} and the traces of \mathbf{X} , \mathbf{Y} , \mathbf{XY}^{-1} satisfy the Markov equations (see [12]):

$$\begin{aligned} \mathrm{tr}^2(\mathbf{X}) + \mathrm{tr}^2(\mathbf{Y}) + \mathrm{tr}^2(\mathbf{XY}) &= \mathrm{tr}(\mathbf{X}) \mathrm{tr}(\mathbf{Y}) \mathrm{tr}(\mathbf{XY}) \\ \mathrm{tr}^2(\mathbf{X}) + \mathrm{tr}^2(\mathbf{Y}) + \mathrm{tr}^2(\mathbf{XY}^{-1}) &= \mathrm{tr}(\mathbf{X}) \mathrm{tr}(\mathbf{Y}) \mathrm{tr}(\mathbf{XY}^{-1}) \end{aligned}$$

As above, to simplify the notation, we define

$$\begin{aligned} x &= \cosh \lambda(\mathbf{X}) = \frac{1}{2} \mathrm{tr}(\mathbf{X}), \\ y &= \cosh \lambda(\mathbf{Y}) = \frac{1}{2} \mathrm{tr}(\mathbf{Y}), \\ A &= \cosh \lambda(\mathbf{XY}) = \frac{1}{2} \mathrm{tr}(\mathbf{XY}), \\ B &= \cosh \lambda(\mathbf{XY}^{-1}) = \frac{1}{2} \mathrm{tr}(\mathbf{XY}^{-1}). \end{aligned}$$

From the Markov equations we see that A and B are the two roots of the equation

$$t^2 - 2xyt + x^2 + y^2 = 0.$$

Therefore, by the Vietta theorem,

$$\begin{aligned} 2xy &= A + B > 2 \\ x^2 + y^2 &= AB > 1. \end{aligned}$$

In particular, both of these quantities are real. We obtain the following analogue of Proposition 2.1.

Proposition 3.1. *Suppose that $\langle X, Y \rangle$ is a punctured torus group for which $A = \cosh \lambda(\mathbf{XY}) > 1$ and $B = \cosh \lambda(\mathbf{XY}^{-1}) > 1$.*

- (i) *If $(A + B) \leq AB$ then $\langle X, Y \rangle$ is Fuchsian.*
- (ii) *If $(A + B) > AB$ then $\cosh \lambda(\mathbf{Y}) = \overline{\cosh \lambda(\mathbf{X})}$, which is not real.*

Proof. (i) In this case we have, by hypothesis, that

$$\begin{aligned} 0 &\leq AB - A - B = x^2 + y^2 - 2xy = (x - y)^2, \\ 0 &< AB + A + B = x^2 + y^2 + 2xy = (x + y)^2. \end{aligned}$$

Therefore $x - y$ and $x + y$ are real, and so x and y are both real. Thus we have $\text{tr}(\mathbf{X}) = 2x$, $\text{tr}(\mathbf{Y}) = 2y$ and $\text{tr}(\mathbf{XY}) = 2A$ all being real. Therefore $\langle X, Y \rangle$ maps a hyperplane in \mathbb{H}^3 to itself. Thus $\langle X, Y \rangle$ is a two generator group of isometrics of the hyperbolic plane for which the commutator of the generators is parabolic. Hence this group is discrete [8].

(ii) In this case, by hypothesis, we have

$$0 > AB - A - B = x^2 + y^2 - 2xy = (x - y)^2.$$

Therefore $x - y$ is purely imaginary. Together with the fact that $x + y$ is real we see that $\cosh \lambda(\mathbf{X}) = x$ and $\cosh \lambda(\mathbf{Y}) = y$ are (non-real) complex conjugates of one another. \square

In what follows we will be interested in the case where $AB < A + B$, that is the non-Fuchsian case. Unless we indicate otherwise we always assume that we are in this case.

Lemma 3.2. *Let $\langle X, Y \rangle$ be a punctured torus group where $A = \cosh \lambda(\mathbf{XY})$ and $B = \cosh \lambda(\mathbf{XY}^{-1})$ are both real and greater than 1. Then the axes of X and Y intersect with angle $\theta(X, Y)$ where*

$$\cos^2 \theta(X, Y) = \frac{(A - B)^2}{(A - B)^2 + 4}.$$

Proof. Calculating the complex distance $\delta(X, Y)$ as before, we obtain equation (1). Squaring this expression and substituting for $2xy = A + B$

and $x^2 + y^2 = AB$ we find that

$$\cosh^2 \delta(X, Y) = \frac{(A - B)^2}{(A - B)^2 + 4}.$$

As this is real and less than 1 we see that $\Re \delta(X, Y) = 0$. In other words, the axes of X and Y intersect with angle $\Im \delta(X, Y) = \theta(X, Y)$. This gives the result. \square

Now we will construct the fundamental polyhedron for the convex core of $\langle X, Y \rangle$. This will be $\tilde{\mathcal{Q}} = \tilde{\mathcal{Q}}(\alpha, \beta)$.

Since \mathbf{XY} , $(\mathbf{YX})^{-1}$ and their product $\mathbf{XYX}^{-1}\mathbf{Y}^{-1}$ all have real trace, the corresponding isometries XY , $(YX)^{-1}$ and $XYX^{-1}Y^{-1}$ generate a Fuchsian group. Likewise, since \mathbf{XY}^{-1} , $(\mathbf{Y}^{-1}\mathbf{X})^{-1}$ and $\mathbf{XY}^{-1}\mathbf{X}^{-1}\mathbf{Y}$ all have real trace, the corresponding isometries XY^{-1} , $(Y^{-1}X)^{-1}$ and $XY^{-1}X^{-1}Y$ too generate a Fuchsian group.

- Let Π_+ be the plane preserved by the group $\langle XY, YX \rangle$;
- Let Π_- be the plane preserved by the group $\langle XY^{-1}, Y^{-1}X \rangle$.

Following the construction in Section 2.1, we define geodesics γ_X , γ_Y and γ_0 by

- γ_X is the axis of X ;
- γ_Y is the axis of Y ;
- γ_0 is the common perpendicular of γ_X and γ_Y .

We define the following halfturns:

- Let I_0 denote the halfturn fixing γ_0 .
- Define I_1 by $I_1 = I_0X$. Then I_1 is a halfturn fixing a geodesic γ_1 .
- Define I_2 by $I_2 = YI_0$. Then I_2 is a halfturn fixing a geodesic γ_2 .

Thus γ_1 is orthogonal to γ_X and the complex distance along γ_X between γ_0 and γ_1 is $\lambda(\mathbf{X})$. Similarly, γ_2 is orthogonal to γ_Y and the complex distance between γ_0 and γ_2 is $\lambda(\mathbf{Y}) = \overline{\lambda(\mathbf{X})}$. Moreover, we have

$$\begin{aligned} I_0XI_0 &= X^{-1}, & I_1XI_1 &= X^{-1}, & I_2XI_2 &= YX^{-1}Y^{-1}, \\ I_0YI_0 &= Y^{-1}, & I_1YI_1 &= X^{-1}Y^{-1}X, & I_2YI_2 &= Y^{-1}. \end{aligned}$$

We claim that

Lemma 3.3. *The geodesic γ_0 is orthogonal to Π_+ and Π_- .*

Proof. We have

$$I_0(XY)I_0 = (YX)^{-1}, \quad I_0(XY^{-1})I_0 = (Y^{-1}X)^{-1}.$$

In other words I_0 interchanges the axes of XY and YX and so preserves Π_+ . Likewise, I_0 interchanges the axes of XY^{-1} and $Y^{-1}X$ and so

preserves Π_- . Moreover,

$$\begin{aligned} I_0 (XYX^{-1}Y^{-1}) I_0 &= (YXY^{-1}X^{-1})^{-1}, \\ I_0 (XY^{-1}X^{-1}Y) I_0 &= (YX^{-1}Y^{-1}X)^{-1}. \end{aligned}$$

Thus I_0 swaps the fixed points of $XYX^{-1}Y^{-1}$ and $YXY^{-1}X^{-1}$ which lie on the boundary of Π_+ . Since these two fixed points are not separated by the axes of XY and YX , elementary plane hyperbolic geometry shows that I_0 acts on Π_+ as a rotation. Similarly, I_0 swaps the fixed points of $XY^{-1}X^{-1}Y$ and $YX^{-1}Y^{-1}X$ and so acts on Π_- as a rotation. This gives the result. \square

Consider a plane Π_0 containing γ_0 so that the angle between Π_0 and γ_X is the same as the angle between Π_0 and γ_Y . There are two planes with this property. Let Π_0 be the plane separating $\gamma_X \cap \gamma_1$ and $\gamma_Y \cap \gamma_2$. Let Π_1 be the other such plane.

- Let R_0 be reflection in Π_0 ;
- Let R_1 be reflection in Π_1 ;
- Then $R_0(\gamma_X) = R_1(\gamma_X) = \gamma_Y$;
- $R_0(\gamma_1) = \gamma_2$;
- $R_0R_1 = I_0$.

For the penultimate line we used $\cosh \lambda(\mathbf{Y}) = \overline{\cosh \lambda(\mathbf{X})}$. Furthermore, we have

$$R_0I_0R_0 = I_0, \quad R_0I_1R_0 = I_2, \quad R_0I_2R_0 = I_1.$$

Hence

$$R_0XR_0 = R_0I_0I_1R_0 = I_0I_2 = Y^{-1}, \quad R_0YR_0 = R_0I_2I_0R_0 = I_1I_0 = X^{-1}.$$

Because $I_0 = R_0R_1$, we see that Π_1 contains γ_0 and that Π_0 and Π_1 are orthogonal.

$$R_1XR_1 = R_0I_0XR_0 = Y, \quad R_1YR_1 = R_0I_0YI_0R_0 = X.$$

Lemma 3.4. *The planes Π_0 and Π_1 satisfy:*

- (i) Π_0 is orthogonal to the axes of XY and YX , and hence to Π_+ ;
- (ii) Π_0 is orthogonal to Π_- and contains the fixed points of parabolic isometries $XY^{-1}X^{-1}Y$ and $YX^{-1}Y^{-1}X$;
- (iii) Π_1 is orthogonal to the axes of XY^{-1} and $Y^{-1}X$, and hence to Π_- ;
- (iv) Π_1 is orthogonal to Π_+ and contains the fixed points of parabolic isometries $XYX^{-1}Y^{-1}$ and $YXY^{-1}X^{-1}$.

Proof. We prove (i) and (ii). Parts (iii) and (iv) will follow similarly.

$$R_0(XY)R_0 = (XY)^{-1}, \quad R_0(YX)R_0 = (YX)^{-1}$$

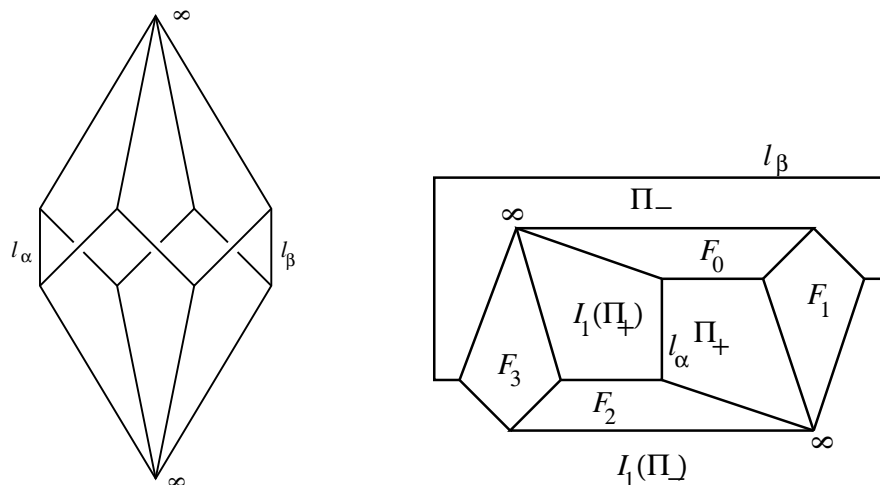
FIGURE 5. The polyhedron $\mathcal{Q}(\alpha, \beta)$.

and so R_0 preserves the axes of XY and YX . Hence Π_0 is orthogonal to Π_+ . Similarly,

$$R_0(XY^{-1})R_0 = Y^{-1}X, \quad R_0(Y^{-1}X)R_0 = XY^{-1}$$

and so R_0 swaps the axes of XY^{-1} and $Y^{-1}X$. Hence it preserves Π_- and so Π_0 is orthogonal to Π_- . Furthermore,

$$\begin{aligned} R_0(XY^{-1}X^{-1}Y)R_0 &= (XY^{-1}X^{-1}Y)^{-1}, \\ R_0(YX^{-1}Y^{-1}X)R_0 &= (YX^{-1}Y^{-1}X)^{-1}. \end{aligned}$$

Thus R_0 fixes their fixed points, which must lie in Π_0 . \square

Let \mathcal{Q} be the hyperbolic polyhedron formed by the common intersection of halfspaces bounded by Π_+ , Π_- , Π_0 , Π_1 and their images under I_1 . For $i = 0, 1$ let F_i, F_{i+2} be the face of \mathcal{Q} contained in $\Pi_i, I_1(\Pi_i)$ respectively (see Figure 5).

The intersection of the faces Π_+ and $I_1(\Pi_+)$ is the segment of the axis of YX with length $\ell_\alpha = \lambda(\mathbf{XY})$. Let us denote the dihedral angle at this edge by α . (This is twice the angle between the axis of I_1 and the plane Π_+ .) Similarly, the intersection of the faces Π_- and $I_1(\Pi_-)$ is the segment of the axis of $Y^{-1}X$ with length $\ell_\beta = \lambda(\mathbf{XY}^{-1})$. We denote the dihedral angle at this edge by β . (This is twice the angle between the axis of I_1 and the plane Π_- .) By the construction, all other dihedral angles of \mathcal{Q} are right angles.

We see that planes Π_1 and $I_1(\Pi_0)$ meet at the fixed point of the parabolic isometry $X^{-1}Y^{-1}XY$. This point is also on Π_+ and $I_1(\Pi_-)$. Therefore faces F_1 and F_2 have a common point at infinity. Likewise, Π_0

and $I_1(\Pi_1)$ meet at the fixed point of the isometry $YX^{-1}Y^{-1}X$ which also lies on Π_- and $I_1(\Pi_+)$. Similarly, F_0 and F_3 have a common point at infinity too. All other vertices of \mathcal{Q} are ordinary. To summarise:

Proposition 3.5. *The polyhedron \mathcal{Q} has ten vertices. Two of these are ideal vertices and are the fixed points of $X^{-1}Y^{-1}XY$ and $YX^{-1}Y^{-1}X$. The other eight vertices are finite and correspond to the intersection of the axes of YX , $Y^{-1}X$, I_0 and $I_1I_0I_1$ with the common perpendiculars of the axes of I_0 , YX ; I_0 , $Y^{-1}X$; $I_1I_0I_1$, YX ; $I_1I_0I_1$, $Y^{-1}X$.*

Let \mathcal{Q}' be the hyperbolic polyhedron formed by the common intersection of halfspaces bounded by Π_+ , Π_- , Π_0 , Π_1 and their images under I_2 . For $i = 0, 1$ let F'_i , F'_{i+2} be the face of \mathcal{Q}' contained in Π_i , $I_2(\Pi_i)$ respectively. Clearly R_0 swaps \mathcal{Q} and \mathcal{Q}' . Denote $\tilde{\mathcal{Q}} = \mathcal{Q} \cup \mathcal{Q}'$.

Proposition 3.6. *The polyhedron $\tilde{\mathcal{Q}} = \mathcal{Q} \cup \mathcal{Q}'$ with the side pairings*

$$Id : F_0 \longrightarrow F'_0, \quad Y : F_1 \longrightarrow F'_3, \quad YX : F_2 \longrightarrow F'_2, \quad X : F_3 \longrightarrow F'_1.$$

is a fundamental domain for the convex core of the group $\langle X, Y \rangle$.

Proof. The proof is similar to the proof of Proposition 2.6. Again, it is clear that

$$\mathcal{N} = \bigcup_{T \in \langle X, Y \rangle} T(\mathcal{Q} \cup \mathcal{Q}')$$

is invariant under $\langle X, Y \rangle$ and is convex.

The fact that the boundary of \mathcal{N} consists of the orbit of Nielsen regions of the Fuchsian subgroups $\langle XY, YX \rangle$ and $\langle XY^{-1}, Y^{-1}X \rangle$ means that it is contained in the Nielsen region of $\langle X, Y \rangle$. This gives the result. \square

3.2. The trigonometry from bending formulae. In this section we use the bending formulae of [12] to show that \mathcal{Q} only depends on the dihedral angles across the axes of XY and XY^{-1} .

The only free parameters for \mathcal{Q} are the lengths and dihedral angles in the sides of \mathcal{Q} contained in the axes of XY and $Y^{-1}X$. According to the above notation, α is the dihedral angle between Π_+ and $I_1(\Pi_+)$ along the axis of YX and we define ℓ_α to be length of the corresponding side of \mathcal{Q} . According to the above notation, β is the dihedral angle between Π_- and $I_1(\Pi_-)$ along the axis of $Y^{-1}X$ and we define ℓ_β to be length of the corresponding side of \mathcal{Q} .

We now show how to relate α , β , ℓ_α , ℓ_β using the formulae of Parker and Series [12]. Now the pleating loci are next-but-one neighbours with common neighbour X . It is easy to see that the real part of the translation along XY is half the length of this curve, that is $\lambda(\mathbf{XY})$.

Also, from the way the polyhedron is constructed, we see that ℓ_α is $\lambda(\mathbf{XY})$. Likewise for the other face. Therefore, using the formula (I) of [12] (with $U = X$) first with $\lambda(W) = \ell_\alpha$, $\tau = \ell_\alpha + i(\pi - \alpha)$ and then with $\lambda(W) = \ell_\beta$, $\tau = \ell_\beta + i(\pi - \beta)$ we obtain

$$\cosh^2 \lambda(\mathbf{X}) = \frac{\cosh^2(\ell_\alpha/2 + i(\pi - \alpha)/2)}{\tanh^2 \ell_\alpha} = \frac{\cosh^2(\ell_\beta/2 + i(\pi - \beta)/2)}{\tanh^2 \ell_\beta}.$$

Taking square roots and equating the real and imaginary parts we obtain

$$\begin{aligned} \frac{\cosh(\ell_\alpha/2) \sin(\alpha/2)}{\tanh(\ell_\alpha)} &= \pm \frac{\cosh(\ell_\beta/2) \sin(\beta/2)}{\tanh(\ell_\beta)}, \\ \frac{\sinh(\ell_\alpha/2) \cos(\alpha/2)}{\tanh(\ell_\alpha)} &= \pm \frac{\sinh(\ell_\beta/2) \cos(\beta/2)}{\tanh(\ell_\beta)}. \end{aligned}$$

Squaring and using the duplication formula for \cos and \cosh we obtain

Proposition 3.7. *The (essential) angles α , β and the edge lengths ℓ_α , ℓ_β of $\mathcal{Q} = \mathcal{Q}(\alpha, \beta)$ are related by*

$$\frac{A^2(1 - \cos \alpha)}{A - 1} = \frac{B^2(1 - \cos \beta)}{B - 1}, \quad \frac{A^2(1 + \cos \alpha)}{A + 1} = \frac{B^2(1 + \cos \beta)}{B + 1},$$

where $A = \cosh \ell_\alpha$ and $B = \cosh \ell_\beta$.

These formulae indicate that the polyhedron \mathcal{Q} only depends on the angles α and β , where $\alpha, \beta \in (0, \pi)$. This justifies our notation $\mathcal{Q} = \mathcal{Q}(\alpha, \beta)$ and $\tilde{\mathcal{Q}} = \tilde{\mathcal{Q}}(\alpha, \beta)$. In the next section we will see how to write A and B in terms of $\cos \alpha$ and $\cos \beta$.

It easy to see from proposition 3.7 that the following relation follows:

$$\frac{\tan(\alpha/2)}{\tanh(\ell_\alpha/2)} = \frac{\tan(\beta/2)}{\tanh(\ell_\beta/2)} = T$$

for some parameter T , but to find it we need to know more relations between essential angles and lengths. The effective way to obtain these relations is to consider the Gram matrix.

3.3. The trigonometry from the Gram matrix. In this section we consider the Gram matrix of \mathcal{Q} and re-derive the formulae from the previous section.

Consider the numbering of faces of $\mathcal{Q}(\alpha, \beta)$, for $0 < \alpha, \beta < \pi$, as shown on its projection in Figure 6. Let $\rho(i, j)$ be the distance between faces of $\mathcal{Q}(\alpha, \beta)$ with numbers i and j . Denote $A = \cosh \ell_\alpha$, $B = \cosh \ell_\beta$, $u = \cosh d = \cosh \rho(2, 5) = \cosh \rho(4, 7)$, $v = \cosh \rho(2, 8) = \cosh \rho(1, 7)$, $w = \cosh \rho(3, 5) = \cosh \rho(4, 6)$.

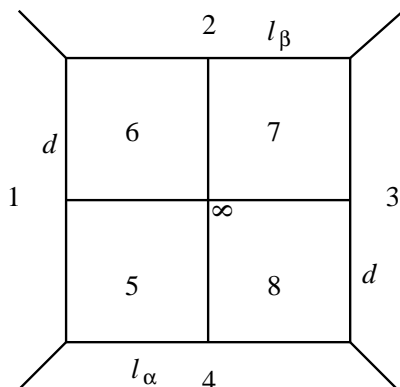
FIGURE 6. The polyhedron $\mathcal{Q}(\alpha, \beta)$.

Remark that the edges marked by d (which also denotes their lengths) are common perpendiculars to faces 2 and 5, and faces 4 and 7. As we see from the construction, d is distance between planes Π_+ and Π_- .

Let $G_{\alpha, \beta}$ be the Gram matrix of the polyhedron $\mathcal{Q}(\alpha, \beta)$:

$$G_{\alpha, \beta} = \begin{pmatrix} 1 & 0 & -1 & 0 & 0 & 0 & -v & -A \\ 0 & 1 & 0 & -1 & -x & 0 & -\cos \beta & -v \\ -1 & 0 & 1 & 0 & -w & -B & 0 & 0 \\ 0 & -1 & 0 & 1 & -\cos \alpha & -w & -u & 0 \\ 0 & -u & -w & -\cos \alpha & 1 & 0 & -1 & 0 \\ 0 & 0 & -B & -w & 0 & 1 & 0 & -1 \\ -v & -\cos \beta & 0 & -u & -1 & 0 & 1 & 0 \\ -A & -v & 0 & 0 & 0 & -1 & 0 & 1 \end{pmatrix}$$

Denote by $G(i_1, i_2, \dots, i_k)$, $k \leq 8$, the diagonal minor of $G_{\alpha, \beta}$, formed by rows and columns with numbers i_1, i_2, \dots, i_k . Since the rank of $G_{\alpha, \beta}$ is equal to 4 the determinants of each of its 5×5 -minors $\det G(i_1, i_2, i_3, i_4, i_5)$ will vanish. Again, this gives relations between the entries of $G_{\alpha, \beta}$. Taking the minors corresponding to the columns (1, 2, 4, 5, 6), (1, 2, 5, 6, 7), (1, 2, 4, 5, 8), (2, 3, 4, 6, 8), (1, 2, 5, 6, 8), (1, 2, 3, 5, 6) respectively, we obtain following six equations.

$$(17) \quad w^2(u^2 - 1) = (u + \cos \alpha)^2,$$

$$(18) \quad v^2(u^2 - 1) = (u + \cos \beta)^2,$$

$$(19) \quad (A^2 - 1)(u + \cos \alpha)^2 = v^2(1 - \cos^2 \alpha),$$

$$(20) \quad (B^2 - 1)(u + \cos \beta)^2 = w^2(1 - \cos^2 \beta),$$

$$(21) \quad v^2 = A^2(u^2 - 1),$$

$$(22) \quad w^2 = B^2(u^2 - 1).$$

Recall that quantities A , B , u , v and w are greater than 1 in these equations. From equations (17) and (22) we get

$$(23) \quad B(u^2 - 1) = (u + \cos \alpha).$$

Substituting (22) into (20) we have

$$B^2(1 + u \cos \beta)^2 - (u + \cos \beta)^2 = 0.$$

Factorising this equation and substituting for B from (23) we obtain

$$f_{\alpha,\beta}(u) g_{\alpha,\beta}(u) = 0,$$

where

$$(24) \quad f_{\alpha,\beta}(u) = u^3 - u(2 + \cos \alpha \cos \beta) - \cos \alpha - \cos \beta$$

and

$$g_{\alpha,\beta}(u) = u^3 + 2u^2 \cos \beta + u \cos \alpha \cos \beta + \cos \alpha - \cos \beta.$$

Analogously, from (18) and (21) we get

$$(25) \quad A(u^2 - 1) = (u + \cos \beta),$$

and substituting (21) into (19), we obtain

$$A^2(1 + u \cos \alpha)^2 - (u + \cos \alpha)^2 = 0,$$

which gives

$$f_{\alpha,\beta}(u) g_{\beta,\alpha}(u) = 0.$$

Therefore, u is a root of the equation

$$f_{\alpha,\beta}(u) h_{\alpha,\beta}(u) = 0,$$

where

$$h_{\alpha,\beta}(u) = g_{\alpha,\beta}(u) - g_{\beta,\alpha}(u) = 2(u^2 - 1)(\cos \beta - \cos \alpha).$$

We remark that equations $h_{\alpha,\beta}(u) = 0$ and $g_{\alpha,\alpha}(u) = 0$ have no roots with $u > 1$. Therefore, $f_{\alpha,\beta}(u) = 0$. It is easy to see that if $\alpha \neq \pi$ and $\beta \neq \pi$ then $f_{\alpha,\beta}(1) < 0$. Furthermore, $f_{\alpha,\beta}(u)$ is strictly increasing on the interval $(1, \infty)$, and so has only one root u with $u > 1$. Using (23) and (25) to substitute for $\cos(\alpha)$ and $\cos(\beta)$ in (24) we find that for such a root u we have

$$(26) \quad u = \frac{A + B}{AB}.$$

Therefore we obtain

$$(27) \quad \cos \alpha = \frac{A + B - A^2 B}{A^2}, \quad \cos \beta = \frac{A + B - AB^2}{B^2}.$$

These equations are equivalent to the formulae in Proposition 3.7.

From this it is easy to see that the following four conditions are equivalent: (i) $u = 1$; (ii) $\cos \alpha = -1$; (iii) $\cos \beta = -1$; (iv) $A + B =$

AB . They correspond to the case when the polyhedron $\mathcal{Q}(\alpha, \beta)$ has collapsed. As we saw in Proposition 3.1, the polyhedron $\mathcal{Q}(\alpha, \beta)$ is non-degenerate if and only if $A + B > AB$.

Substituting for $B = A/(Au - 1)$ and $A = B/(Bu - 1)$ into the expressions for $\cos \alpha$ and $\cos \beta$ in (27) gives

$$\cos \alpha = \frac{u - A}{Au - 1}, \quad \cos \beta = \frac{u - B}{Bu - 1}.$$

Rearranging gives

$$(28) \quad A = \frac{u + \cos \alpha}{1 + u \cos \alpha}, \quad B = \frac{u + \cos \beta}{1 + u \cos \beta}.$$

Combining these with the expression for u given in (24) we obtain:

Proposition 3.8. *For a non-degenerate polyhedron $\mathcal{Q}(\alpha, \beta)$, the parameters $A = \cosh \ell_\alpha$ and $B = \cosh \ell_\beta$ can be found by*

$$A = \frac{u + \cos \alpha}{1 + u \cos \alpha} \quad B = \frac{u + \cos \beta}{1 + u \cos \beta},$$

where $u > 1$ is the root of the equation

$$(29) \quad u^3 - u(2 + \cos \alpha \cos \beta) - \cos \alpha - \cos \beta = 0.$$

Recall that by definition $u = \cosh d$, where d is distance between planes Π_+ and Π_- . Set $T = \coth(d/2)$, and note that $T^2 = (u + 1)/(u - 1)$. Using standard relations

$$\cos \nu = \frac{1 - \tan^2(\nu/2)}{1 + \tan^2(\nu/2)}, \quad \cosh \mu = \frac{1 + \tanh^2(\mu/2)}{1 - \tanh^2(\mu/2)},$$

we are able to rewrite the above proposition in the following way:

Proposition 3.9 (Tangent Rule). *The (essential) angles α , β and the edge lengths ℓ_α , ℓ_β of the polyhedron $\mathcal{Q}(\alpha, \beta)$ are related by*

$$(30) \quad \frac{\tan(\alpha/2)}{\tanh(\ell_\alpha/2)} = \frac{\tan(\beta/2)}{\tanh(\ell_\beta/2)} = T,$$

where T is a positive number given by $T^2 = (u + 1)/(u - 1)$, and u is a root of the equation (29).

Remark that $u = (T^2 + 1)/(T^2 - 1)$, and it follows from (29) that u satisfies the equation

$$(u^2 - 1)^2 = (u \cos \alpha + 1)(u \cos \beta + 1).$$

By direct computations, we see that T satisfies the equation

$$\frac{T^2 - M^2}{1 + M^2} \frac{T^2 - N^2}{1 + N^2} \left[\frac{T^2 - 1}{2T^2} \right]^2 = 1,$$

where $M = \tan(\alpha/2)$ and $N = \tan(\beta/2)$.

3.4. Volume formulae. In this section we use Schläfli's formula to find the volume of $\mathcal{Q}(\alpha, \beta)$.

By the construction, the volume of the convex hull $\tilde{\mathcal{Q}}(\alpha, \beta)$ is twice the volume of the polyhedron $\mathcal{Q}(\alpha, \beta)$. To find the volume of the latter polyhedron, we will use the method of the extended Schläfli differential form. Consider Schläfli's differential form

$$\omega = d \mathbf{Vol} \mathcal{Q}(\alpha, \beta) = -\frac{1}{2} (\ell_\alpha d\alpha + \ell_\beta d\beta)$$

defined for $0 < \alpha, \beta < \pi$. Let us extend it to a differential form $\Omega = \Omega(\alpha, \beta, u)$ of three independent variables α, β, u :

$$\Omega = -\frac{1}{2} (\ell_\alpha d\alpha + \ell_\beta d\beta + \ell_u du),$$

where u plays a role of the principal parameter. We have to choose Ω in such a way that following properties are satisfied:

- Ω is smooth and exact in the region
 $G = \{(\alpha, \beta, u) \in \mathbb{R}^3 : 0 < \alpha < \pi, 0 < \beta < \pi, u > 1\}$;
- $\Omega = \omega$ for all $(\alpha, \beta, u) \in G$ satisfying equation (29).

Since Ω is supposed to be exact, we have

$$\frac{\partial \ell_u}{\partial \alpha} = \frac{\partial \ell_\alpha}{\partial u} = \frac{\partial}{\partial u} \left(\operatorname{arccosh} \frac{u + \cos \alpha}{1 + u \cos \alpha} \right) = \frac{\sin \alpha}{(1 + u \cos \alpha) \sqrt{u^2 - 1}}.$$

So

$$\begin{aligned} \ell_u &= \int \frac{\sin \alpha d\alpha}{(1 + u \cos \alpha) \sqrt{u^2 - 1}} \\ &= -\frac{1}{u \sqrt{u^2 - 1}} \log(1 + u \cos \alpha) + C(u, \beta) \\ &= -\frac{1}{u \sqrt{u^2 - 1}} \log \frac{(1 + u \cos \alpha)(1 + u \cos \beta)}{(u^2 - 1)^2}. \end{aligned}$$

We note that for $u > 1$ the equation (29) is equivalent to

$$\frac{(1 + u \cos \alpha)(1 + u \cos \beta)}{(u^2 - 1)^2} = 1.$$

If this condition is satisfied, we have $\ell_u = 0$ and consequently $\Omega = \omega$.

Applying the same arguments as in Theorem 2.9, we find

Theorem 3.10. *The volume of the convex hull $\tilde{\mathcal{Q}}(\alpha, \beta)$ is given by*

$$\mathbf{Vol} \tilde{\mathcal{Q}}(\alpha, \beta) = \int_1^u \log \left[\frac{(1 + \zeta \cos \alpha)(1 + \zeta \cos \beta)}{(\zeta^2 - 1)^2} \right] \cdot \frac{d\zeta}{\zeta \sqrt{\zeta^2 - 1}},$$

where $u > 1$ is the root of the equation (29).

If $\alpha = \beta$, then $u = \frac{1}{2}(\cos \alpha + \sqrt{8 + \cos^2 \alpha})$, and

$$\begin{aligned} \mathbf{Vol} \tilde{\mathcal{Q}}(\alpha, \alpha) &= 2 \int_1^u \log \frac{1 + \zeta \cos \alpha}{\zeta^2 - 1} \cdot \frac{d\zeta}{\zeta \sqrt{\zeta^2 - 1}} \\ &= 2 \int_\alpha^\pi \operatorname{arccosh} \frac{\sqrt{8 + \cos^2 \alpha} - \cos \alpha}{2} d\alpha. \end{aligned}$$

Now we want to express $\mathbf{Vol} \tilde{\mathcal{Q}}(\alpha, \beta)$ in term of the Lobachevsky function. To do this we write $M = \tan(\alpha/2)$ and $N = \tan(\beta/2)$ and make the following substitutions in the integral of Theorem 3.10: $\zeta = (t^2+1)/(t^2-1)$, $\cos \alpha = (1-M^2)/(1+M^2)$, and $\cos \beta = (1-N^2)/(1+N^2)$. As a result we obtain:

Corollary 3.11. *The volume of the convex hull $\tilde{\mathcal{Q}}(\alpha, \beta)$ is given by*

$$\mathbf{Vol} \tilde{\mathcal{Q}}(\alpha, \beta) = 2 \int_T^{+\infty} \log \left| \frac{(t^2 - M^2)(t^2 - N^2)}{(1 + M^2)(1 + N^2)} \left(\frac{t^2 - 1}{2t^2} \right)^2 \right| \frac{dt}{1 + t^2},$$

where $M = \tan(\alpha/2)$, $N = \tan(\beta/2)$ and $T = \coth(d/2)$ is the variable from the tangent rule.

Using this result and Lemma 2.10 we have

Corollary 3.12. *The volume of the convex hull $\tilde{\mathcal{Q}}(\alpha, \beta)$ is given by*

$$\begin{aligned} \mathbf{Vol} \tilde{\mathcal{Q}}(\alpha, \beta) &= 2\Delta(\alpha/2, \theta) + 2\Delta(\beta/2, \theta) + \\ &\quad 4\Delta(\pi/4, \theta) - 4\Delta(0, \theta) - 4\Delta(\pi/2, \theta), \end{aligned}$$

where $\Delta(\mu, \sigma) = \Lambda(\mu + \sigma) - \Lambda(\mu - \sigma)$, and θ is a principal parameter such that $T = \tan \theta$.

In particular, $\mathbf{Vol} \mathcal{Q}(0, 0) = 2.53735\dots$, which is the maximal volume for the family $\mathcal{Q}(\alpha, \beta)$. Moreover, $\mathbf{Vol} \mathcal{Q}(\pi/2, \pi/2) = 1.83193\dots$ which is one-half of the volume of the ideal right-angled octahedron.

3.5. The associated cone manifolds. In this section we will determine a link which is naturally related with the polyhedron $\mathcal{Q}(\alpha, \beta)$ in the same manner as the Lambert cube is related with the Borromean rings.

In order to do this we consider $\mathcal{Q}(\alpha, \beta)$ as a particular case of a more general polyhedron $\mathcal{O} = \mathcal{O}(\alpha, \beta, \gamma, \delta, \varepsilon, \nu)$ (see Figure 7). The dihedral angles of \mathcal{O} are equal to $\alpha, \beta, \gamma, \delta, \varepsilon, \nu$ on edges labelled by these letters, and are $\pi/2$ on the other edges. We allow for angles $\alpha, \beta, \gamma, \delta, \varepsilon, \nu$ to be zero. In this case the corresponding edges become ideal

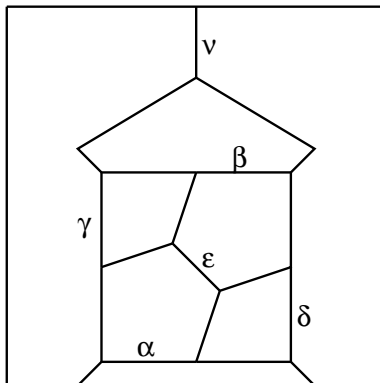

FIGURE 7. The polyhedron $\mathcal{O}(\alpha, \beta, \gamma, \delta, \varepsilon, \nu)$.

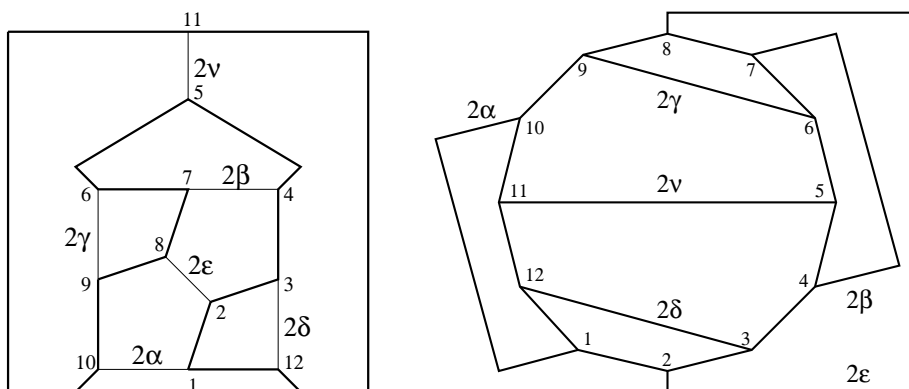
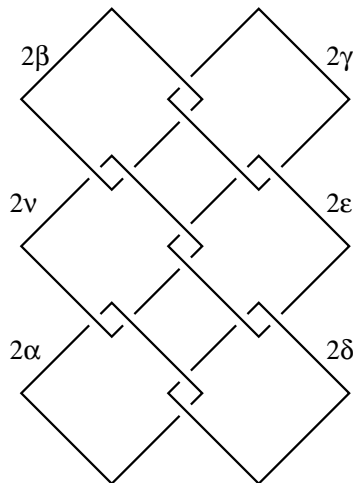

FIGURE 8. Two representations of the singular set of the orbifold Ω^+ .

vertices of polyhedra with a complete hyperbolic structure. Note that for $\alpha = \beta = \gamma = \delta = \varepsilon = \nu = 0$ the polyhedron \mathcal{O} is a regular right angled octahedron. The existence of \mathcal{O} in the hyperbolic space \mathbb{H}^3 for all $0 \leq \alpha, \beta, \gamma, \delta, \varepsilon, \nu < \pi$ follows from Rivin's theorem [13]. We remark that $\mathcal{Q}(\alpha, \beta) = \mathcal{O}(\alpha, \beta, \pi/2, \pi/2, 0, 0)$.

Consider a hyperbolic cone-manifold Ω whose underlying space is the polyhedron \mathcal{O} and whose singular set consists of faces, edges and vertices of \mathcal{O} . Let Ω^+ be an orientable double of Ω . Then Ω^+ can be obtained by gluing together \mathcal{O} and its mirror image along their common boundary. As a result, Ω^+ can be recognised as a hyperbolic cone-manifold with the 3-sphere as its underlying space and whose singular set is formed by the edges of \mathcal{O} with cone angles twice the dihedral ones (see Figure 8, where unlabelled edges correspond to cone angles π).

FIGURE 9. *The link L.*

To construct the two-fold covering we will use the approach from [10] based on the properties of the Hamiltonian circuit. Note that unbranched edges form a Hamiltonian circuit λ passing through all vertices of the singular set of Ω^+ . Consider a two-fold covering $\Sigma \rightarrow \Omega^+$ of Ω^+ branched over the cycle λ . Since λ is unknotted in Ω^+ , the underlying space of Σ is the 3-sphere again. The singular set of Σ is a six component link L formed by lifting the labelled edges. To recognise this link we represent λ as a circle with 12 vertices as in the right hand figure of Figure 8. After taking the two-fold covering branched along λ we obtain the link L (see Figure 9).

Hence $\Sigma = \Sigma(2\alpha, 2\beta, 2\gamma, 2\delta, 2\varepsilon, 2\nu)$ is a hyperbolic cone-manifold with singular set illustrated in Figure 9. By the construction we have

$$(31) \quad \mathbf{Vol} \mathcal{O}(\alpha, \beta, \gamma, \delta, \varepsilon, \nu) = \frac{1}{4} \mathbf{Vol} \Sigma(2\alpha, 2\beta, 2\gamma, 2\delta, 2\varepsilon, 2\nu).$$

In particular, we obtain

Proposition 3.13. *The volume of the convex hull $\tilde{\mathcal{Q}}(\alpha, \beta)$ is equal to one half of the volume of cone-manifold $\Sigma(2\alpha, 2\beta, \pi, \pi, 0, 0)$.*

This statement gives us a convenient way to calculate the volume of $\tilde{\mathcal{Q}}(\alpha, \beta)$ using J. Weeks' computer program *SnapPea* [15].

REFERENCES

- [1] F. Bonahon, *A Schläfli-type formula for convex cores of hyperbolic 3-manifolds*, J. Diff. Geom. **50** (1998), no. 1, 25–58.
- [2] R.D. Canary, D.B.A. Epstein, P. Green, *Notes on notes of Thurston*. Analytical and geometric aspects of hyperbolic space (Coventry/Durham, 1984), 3–92,

- London Math. Soc. Lecture Note Ser. **111**, Cambridge Univ. Press, Cambridge, 1987.
- [3] D.B.A. Epstein, A. Marden, *Convex hulls in hyperbolic space, a theorem of Sullivan, and measured pleated surfaces*. Analytical and geometric aspects of hyperbolic space (Coventry/Durham, 1984), 113–253, London Math. Soc. Lecture Note Ser. **111**, Cambridge Univ. Press, Cambridge, 1987.
 - [4] W. Fenchel, *Elementary Geometry in Hyperbolic Space*, de Gruyter, 1989.
 - [5] H. Hilden, M.T. Lozano, J.M. Montesinos-Amilibia, *On the Borromean orbifolds: Geometry and arithmetic*, Topology '90, Contrib. Res. Semester Low Dimensional Topol., Columbus/OH (USA) 1990, Ohio State Univ. Math. Res. Inst. Publ. **1** (1992), 133–167.
 - [6] R. Kellerhals, *On the volume of hyperbolic polyhedra*, Math. Ann. **285** (1989), 541–569.
 - [7] E. Klimenko, *Some examples of discrete groups and hyperbolic orbifolds of infinite volume*, J. Lie Theory **11** (2001), 491–503.
 - [8] P.J. Matelski, *The classification of discrete 2-generator subgroups of $\mathrm{PSL}(2, \mathbb{R})$* , Israel J. Math. **42** (1982), 309–317.
 - [9] J. Milnor, *The Schläfli differential equality*, in: Collected papers. Vol. 1. Geometry, Publish or Perish, Inc., Houston, TX, 1994, 281–295.
 - [10] A.D. Mednykh, A.Yu. Vesnin, *Three-dimensional hyperelliptic manifolds and Hamiltonian graphs*, Siberian Math. J. **40** (1999), no. 4, 628–643.
 - [11] A.D. Mednykh, A.Yu. Vesnin, *On the volume of hyperbolic Whitehead link cone-manifolds*, SCIENTIA, Series A: Mathematical Sciences, **8** (2002), 1–11.
 - [12] J.R. Parker, C. Series, *Bending formulae for convex hull boundaries*, J. Anal. Math. **67** (1995), 165–198.
 - [13] I. Rivin, *A characterization of ideal polyhedra in hyperbolic 3-space*, Ann. of Math. (2) **143** (1996), no. 1, 51–70.
 - [14] E.B. Vinberg, *Geometry II: spaces of constant curvature*, Encyclopaedia of Mathematical Sciences. Berlin: Springer-Verlag. **29** (1993).
 - [15] J. Weeks, *SnapPea*, Software for hyperbolic 3-manifolds, available at <http://ftp.geometrygames.org/SnapPea/index.html>

SOBOLEV INSTITUTE OF MATHEMATICS, NOVOSIBIRSK 630090, RUSSIA
E-mail address: mednykh@math.nsc.ru

DEPARTMENT OF MATHEMATICAL SCIENCES, UNIVERSITY OF DURHAM, DURHAM,
 DH1 3LE, ENGLAND
E-mail address: j.r.parker@durham.ac.uk

SOBOLEV INSTITUTE OF MATHEMATICS, NOVOSIBIRSK 630090, RUSSIA
E-mail address: vesnin@math.nsc.ru